



# KANGA PRODUCTS

Electronic Kits For The Radio Amateur

## Straight Key Practice Oscillator Kit

There are many practice oscillators available, some good, some bad. The old widely used standard oscillator was built around the infamous 555 multivibrator chip. It works but does have a few problems, typically the pitch changes as the volume changes the loading on the chip and the output can sound a bit rough with a poor duty cycle. They do have their advantages which is that they are simply to build and low cost.



This new Kanga Practice oscillator keeps the advantages of the simpler designs but produces a much more stable tone that remains the same at all volume settings, and there is plenty of volume for classroom or personal use (fitted with a 2inch speaker). The front mounted LED provides visual Indication of the code being sent too. The kit comes with a pre-drilled sturdy enclosure and also provides a headphone output (Fixed Level) for private practice too. Internally the oscillator is powered by a 4 x AAA battery pack that will last a very long time. The pitch can be adjusted by means of a small trimmer on the PCB.

The Kanga oscillator uses a 4047-multivibrator chip. This chip produces a 50% duty cycle output at all frequencies that makes for a more pleasant, richer tone when fitted onto the sealed enclosure provided.

This project is suitable for a beginner and makes a good useful first project.

Let's see the circuit

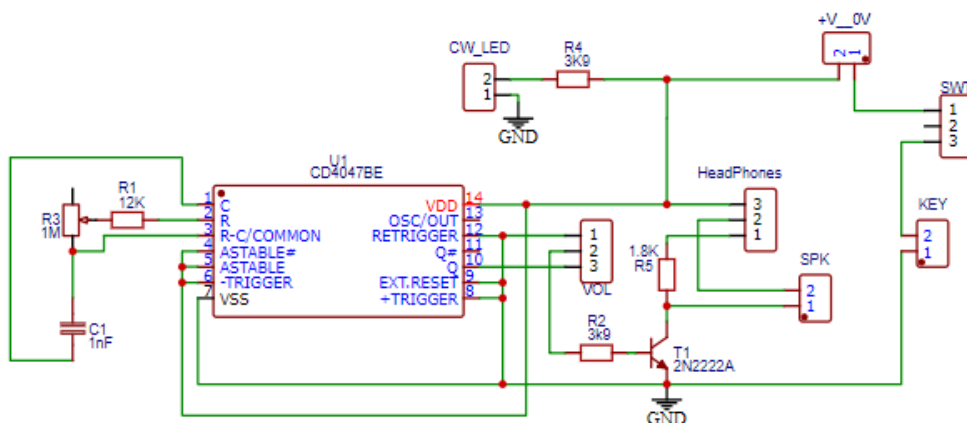



# KANGA PRODUCTS

Electronic Kits For The Radio Amateur

## Kits Parts list

- 1 x PCB
- 1 x CD4047 14 Pin DIP
- 1 x 14 Pin DIP Socket
- 1 x 2N2222 Transistor
- 1 x 3mm CW LED
- 1 x R1 :- 12K ¼ watt Resistor (first 2 bands Brown, Red)
- 2 x R2, R4 :- 3K9 ¼ watt Resistor (first 2 bands Orange, White)
- 1 x R5 :- 1K8 ¼ watt Resistor (first 2 bands Brown, Grey)
- 1 x R3 :- 1M 3 pin Trimmer Resistor (Tone adjustment)
- 1 x 10K volume/On-Off Control
- 1 x C1 :- 1nF Capacitor
- 2 x 2 Way Terminal Block
- 2 x 3.5mm Panel Mount Socket
- 1 x 2 inch 8 ohm Speaker
- 4 x 12mm Metal Washers
- 4 x M3 Nuts
- 4 x 10mm M3 Black Screws
- 1 x 4 Cell AAA Battery Holder
- 1 x Foam Pad
- 1 x Multicore Cable length (approx. 150mm)
- 1 x Control Knob
- 1 x Black ABS Case (Pre-Drilled)
- 1 x Set of Case fixing screws (4 off)
- 1 x Set of stick on feet (4 off)
- 1 x Case Sticker

Please check you have all parts before you start and contact me if you have parts missing.

[Sales@kanga-products.co.uk](mailto:Sales@kanga-products.co.uk)

Once you have checked we are ready to start building.

This kit is popular with first time builders so the instructions are a little more detailed than many kits with more photos and steps that a more experience builder may need. I would still recommend reading ALL the instructions before you start work regardless of your experience level.



# KANGA PRODUCTS

Electronic Kits For The Radio Amateur

Step 1:

## IC Socket

First, we will fit the 14 Pin IC socket, if you carefully at the PCB you will see that one end of the IC socket is shown with a notch.

This is to show which way round to fit the IC Socket and the Chip, the Socket has small notch in one end, the socket should be fitted so the notch is matched to the silk screen printing.

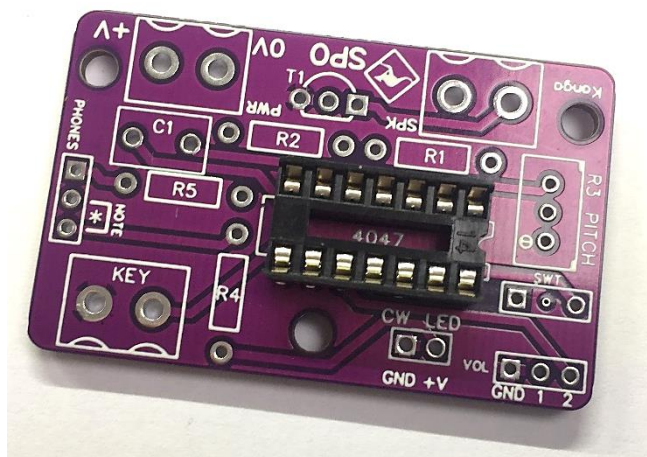
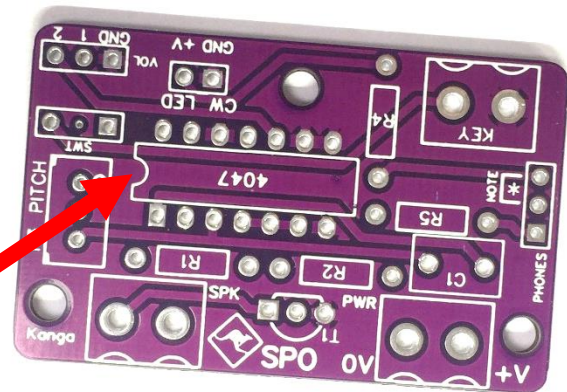

Also, can you notice that just to the left of the notch the first Pin is square and not round like the other pins. This is to tell you which pin is number 1 on the chip, if you look at the chip you will see a small round dot near one pin at one end. This shows pin 1 on the chip itself. When we fit the chip later make sure you fit it so that it's the right way round.

We use sockets so we can change the chip if we ever need to, with so many pins it's difficult to remove a chip.

OK so let's move onto step 2: -

## Fitting the resistors & Capacitor

There are 4 fixed value resistors.

R1= 12K, R2 & R4 =3K9, R5 =1K8

Now resistors can be fitted either way round but they MUST be fitted in the correct locations on the board. you can see that they all have different colour bands. The bands tell use the value of the resistor, to make things more

difficult manufactures use two different systems. Some use 4 bands while others use 5

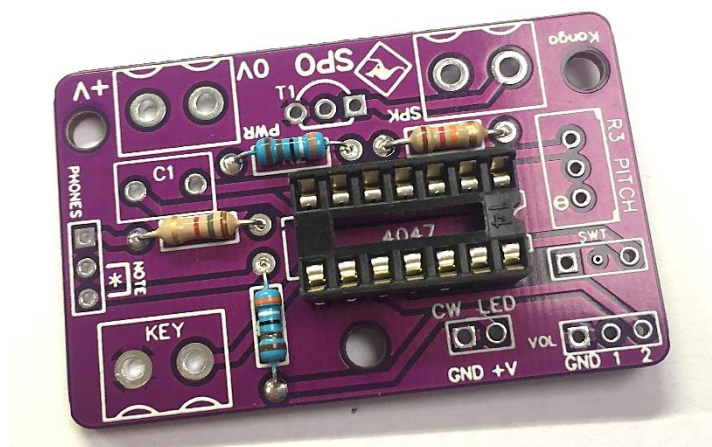



# KANGA PRODUCTS

Electronic Kits For The Radio Amateur

bands. I have provided you with a colour chart that shows how to read these values but the parts list above will also help.

Fit each resistor in turn and carefully solder them into place. Then trim the leads so they are nice and flush at the back of the board.

Do this with all 5 resistors, then double check that the right ones are in the right place.

Now fit the only capacitor in the kit, it's a green 1nF 'pillow' type capacitor, C1.



Check the back of the board for poor soldering or short circuits.

Make a habit of checking your work after each step.

## Step 3 Trimmer Control (Tone/Pitch)

On the PCB you will see a space for the 3-legged Pitch control,

One end of the control has a brass adjustment screw. For now, just leave it where it is, we can adjust that later to set the pitch we like. Solder and trim the leads.



## Step 4

### The Transistor

We need to be able to hear the oscillator so we need to boost the output from the chip to drive the speaker, the device that does that is called an amplifier. In this project we are using a simple transistor as the amplifier. This is a 3-pin black blob of plastic to look at but it is the basic element of the most powerful computer chips, these powerful chips have over 8 billion of these transistors inside, enough for one for every person living on the planet!

Of course we do not need that type of power and a single device is fine for our needs. It must be fitted the right way round, the shape of the transistor is shown on the PCB, make sure you fit it so it looks the same as the silkscreen layout. You do not need to push this right down onto the board aim to leave around 5mm of its leads showing above the board.

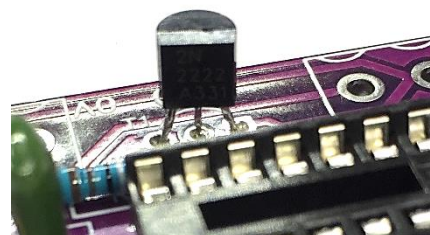



## Step 5 The **terminal Blocks**

There are two terminal blocks to fit, the open terminals of the blocks should be facing outwards from the board. Fit them one by one and carefully solder in place. This can take a little more heat as the pins are a little thicker, take care the pins hold the heat.

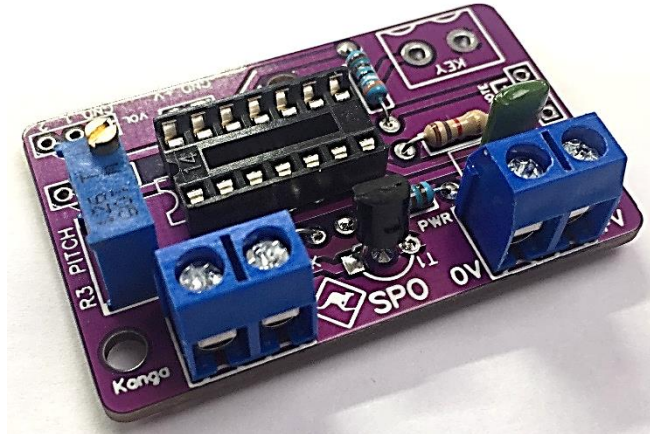

### **A Tip,**

*Now you have the blocks fitted I suggest that you unscrew the terminal blocks so the cable entry points are open, once the terminal have been unscrewed, I tend to put the tip of a small screw driver into the open terminal holes and GENTLY open the hole a little wider so that we can push the wires in later, this will be difficult to do once the board is fitted in the case so I do it at this stage.*

## Step 6 The **Volume Control**

Now this is **VERY IMPORTANT**, if you do not follow these instructions the board will not fit the case correctly. I hope you did read the instructions first before you started building or if you're reading them now because you have a problem, I did warn you.

Right the first thing we need to do is to remove the small metal tag that sticks out from the front of the volume control, I use a pair of cutters for this. Rather than try and cut the tag I use the cutters to hold the tag and then snap it off rather than cut it.

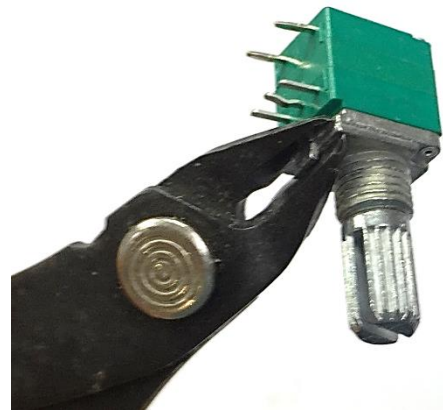

Now we need to fit this control to the board. THIS IS THE **VERY IMPORTANT** Part now.

The Case has a slight slope to the front panel and if we fit the volume control is fitted flush on the PCB it will cause the board to stick up at an angle in the case and not fit. Look at the picture below that shows how to position the control on the board.



# KANGA PRODUCTS

Electronic Kits For The Radio Amateur

The control needs to be positioned so the back is higher than the front, the back legs should JUST be through the board. This allows for the slope on the front panel when we fit it into the case.

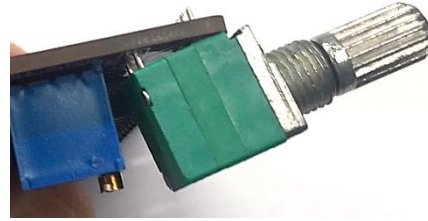

## Step 7 The CW LED

One of the features of the Oscillator is that it in addition to the sound gives visual indication of the Morse being sent. For this we use a bright little 3mm LED. The colour of the LED is not important so you could change the LED to any colour you wish but it needs to be a 3mm one to fit the predrilled hole in the case. Now the LED must be fitted the right way round, look at the LED and you will see that one leg is longer than the other. On the PCB you will notice that

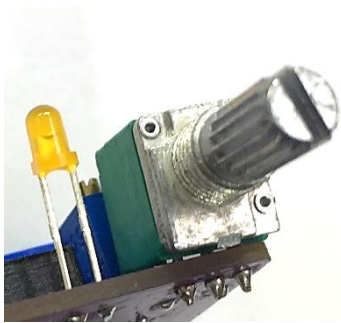
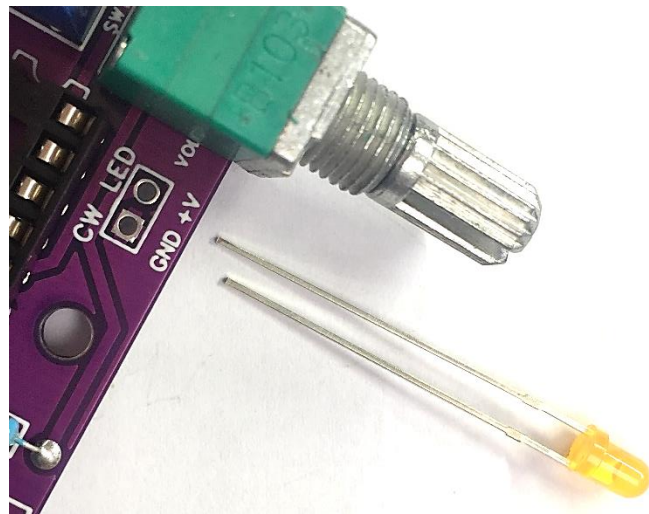

the position marked for the LED has one round and one square hole. The long leg of the led must be in the round hole, double check before you do anything else.

It's important that we do not leave too much of the LEDs legs above the board and also not to mount it too low either. Look at the photo here to show you the correct mounting height. You should aim to get the top of the LED just above the height of the volume control.



# KANGA PRODUCTS

Electronic Kits For The Radio Amateur

## Step 8 **Fold the LED & Fit the Chip**

Fold the LED over so it is level with the PCB.

Then Fit the Chip into the socket, make sure the Notch on the chip is near to the blue trimmer.

Now take a break and double check the PCB for missing parts, blobs of solder causing shorts, or un-soldered leads. Solder related faults are the most likely reason that kits fail to work.

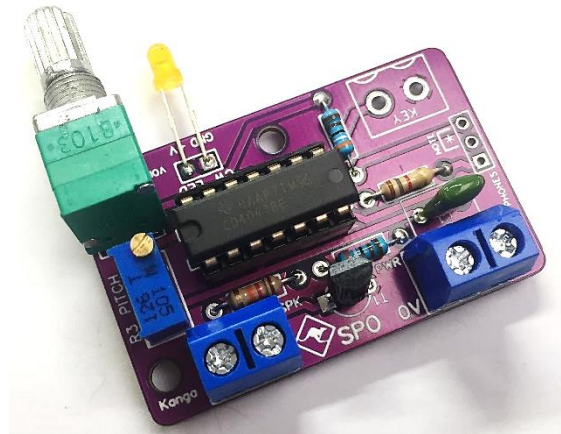



# KANGA PRODUCTS

Electronic Kits For The Radio Amateur

## Step 9 The Key Socket

The key socket has 4 pins but we are only going to use two, if you look carefully at the socket you will see that the layout the pins is as shown here.

I have slightly exaggerated the pin offset just to make it clearer

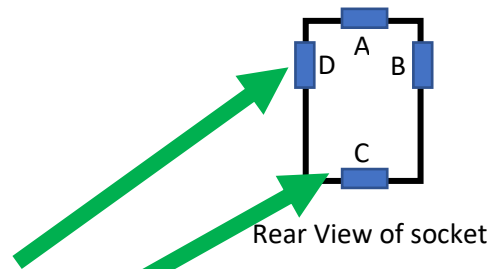

We need to solder two wires to pins shown here has 'D' and 'C'.

These wires should be about 70mm long.

Strip and tin about 5mm of insulation from the other end of the wires.

## Step 10 Head Phone Socket

Again, the pinout of the socket is the same as the Key socket above but this time we are connecting 3 wires.

I have slightly exaggerated the pin offset just to make it clearer

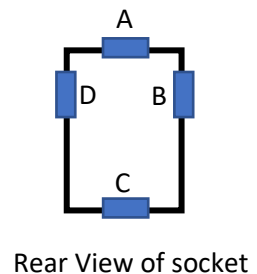

This time we need 3 wires about 150mm long. The colours are not important but use 3 different colours to make things easier.

For both sockets use the heat shrink tubing to cover the soldered pins, you don't HAVE to do this, it just makes for a neater job.

This time solder to pins A, B, & C.

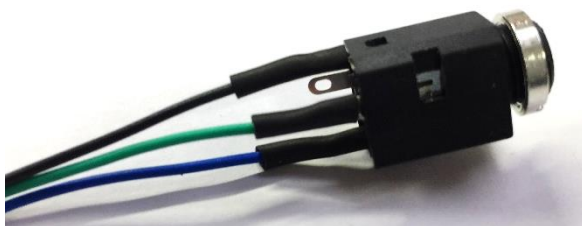

The Headphone socket when soldered





# KANGA PRODUCTS

Electronic Kits For The Radio Amateur

## Step 11 Connecting up the board

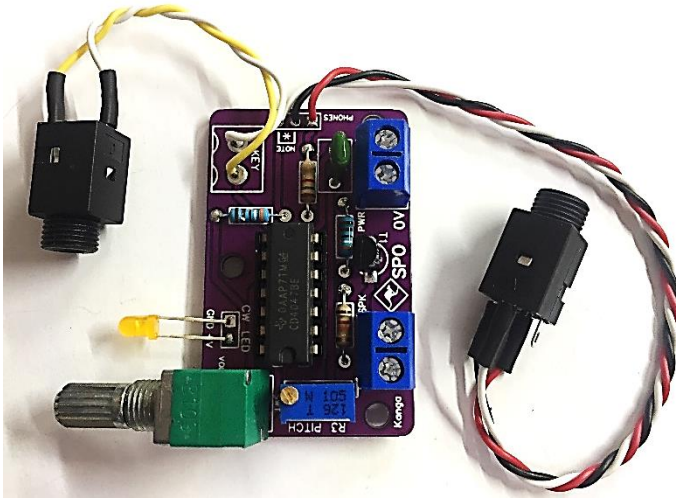

If you haven't done so carefully plug the chip into the board, make sure that you fit it the right way round (see my earlier instructions above)

lightly twist the wires as shown here. Let's start with the easy one the key socket. That the socket with two wires.

Either wire can be fitted in either of the two holes at the front of the board marked 'KEY'

Now the harder socket to wire, the headphone socket.

The headphone socket has 3 wires that connect to pins A, B, and C on the socket as above.

Connect the wires as shown below, this is possibly the hardest part of the build and the part more people get wrong than any other so take your time. You can always email me if you're having problems understand the drawing here.

### Headphone Socket Wiring

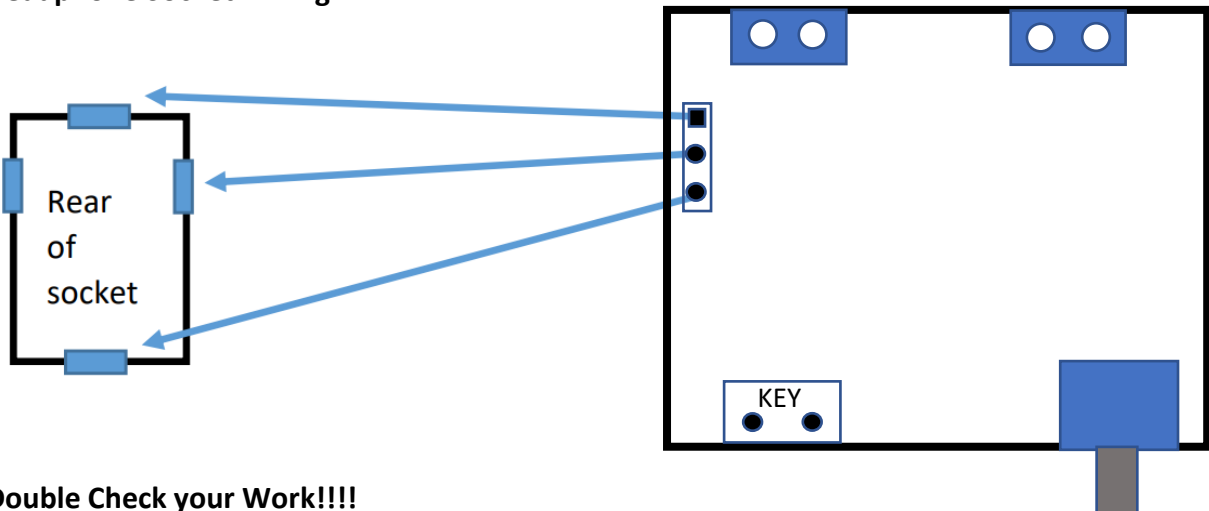

### Double Check your Work!!!!

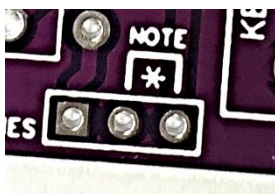

On the Board you will see a '\*Note' printed. IF you did not want to fit the headphone socket or wanted to test the unit without wiring the socket you can put a link on these two pins .



# KANGA PRODUCTS

Electronic Kits For The Radio Amateur

## Step 12 Fitting the board to the case

First check all the holes are free of bits of plastic, I drill these boxes and my eyes are getting old!

Now fit the key socket to the front of the box as shown here, be careful how you tighten the front retaining ring on the socket.

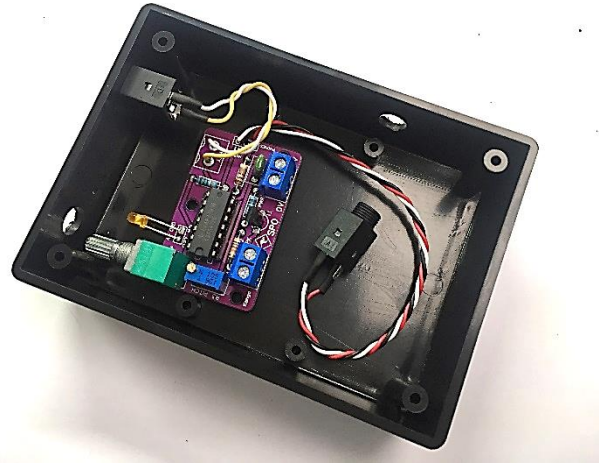

## Next, we will fit the board

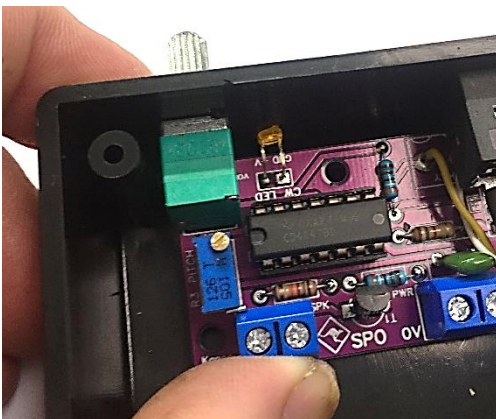

Align the LED with the small 3mm hole in the front panel and the volume control shaft should pass through the larger 8mm hole. Carefully and firmly push the board forward. The LED will pass into the hole and be held there by the flange on its base, the legs of the LED will fold back on themselves as the board moves forward

Use the nut and washer with the volume control to secure it to the front panel. Now turn the control to the off position, you will hear it click. Find the knob

and push it very lightly onto the end of the shaft make sure you like the position of the pointer line before pushing fully onto the shaft, it can be hard to remove it later.

If the knob is hard to fit or feels too loose you can make a small adjustment to the shafts width. The shaft has a long slot in it and you can squeeze the two half's together a little or widen the gap with a broad screw drive tip. **BEWARNED**, you do not need to apply much force to the shaft to do this or you may snap one of the sides off, light pressure and try again will do the job!



Route the headphone wires as shown here and fit the headphone socket in the last hole.

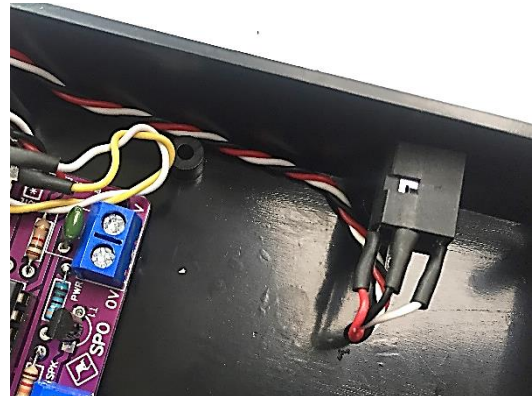

## Step 13 The speaker

We can now move onto the speaker plate.

The speaker is mounted using 4 screws, washers and nuts. A simple but effective way.

First find the 4 black screws and push the through the base plate and put it down on a table top, don't do this on your best oak dining table or you will scratch it.

Then place the speaker in the center of the four screws.

Drop the 4 large washers over the screws so they overlap the edge of the speaker. You should be able to tighten the 4 nuts by hand onto the screws, once the nuts have secured the speaker you can lift the plate and use a screwdriver and nut spinner/pilers to give the screws a little nip so the speaker is secure and will not move.

Find two more wires from the multicore cable provided and solder them to the speaker terminals, leave the leads about 150mm, I tend to twist the wires together at this stage.





# KANGA PRODUCTS

Electronic Kits For The Radio Amateur

Now strip the wires ends, I fold them back over to the insulation a little as I find they seem to grip better in the terminal blocks that way. You can shorten the wires at this stage if feel you want to. Put the wires into the block marked 'SPK'.

Now do the same with the battery holder. Make sure that the red wire from the holder goes into the +V terminal.

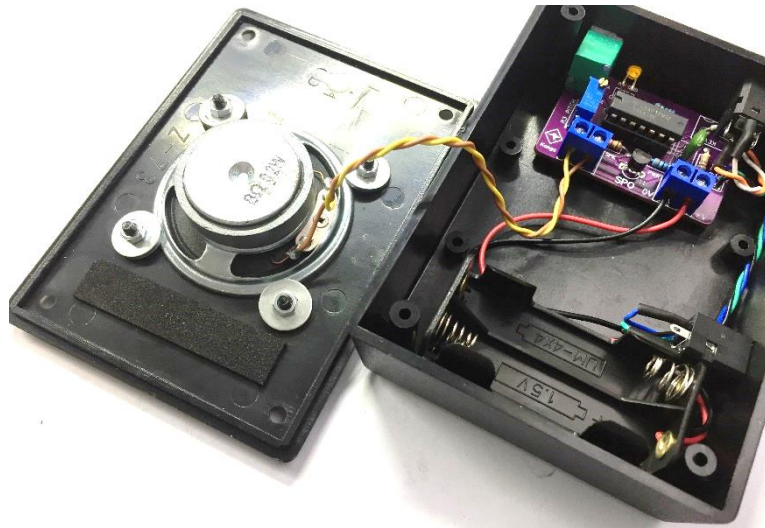

into the +V terminal.

If you look carefully at the picture here, you will see a small foam strip under the speaker, you will have this in your kit. I in the past attached to the front plate as shown here but now just slip it under the battery pack (if needed). The strip stops the battery pack from moving when we put the base on the case.

We can now test the Oscillator, you will need your straight key for this. The key should be wired with a MONO plug! (don't forget the batteries either)

Plug in the key turn the volume about half way and tap the key, if all ok the tone will be heard and the LED will light when the key is pressed.

If nothing happens when you press the key first check that the batteries are fitted correctly, and none the wrong way round. Check that the wires from the two terminal blocks are making contact and have been tightened.

The starting pitch tends to be very low (a few hundred Hz), this will need adjusting to a pitch that we like.



# KANGA PRODUCTS

Electronic Kits For The Radio Amateur

## Step 14 Setting the pitch

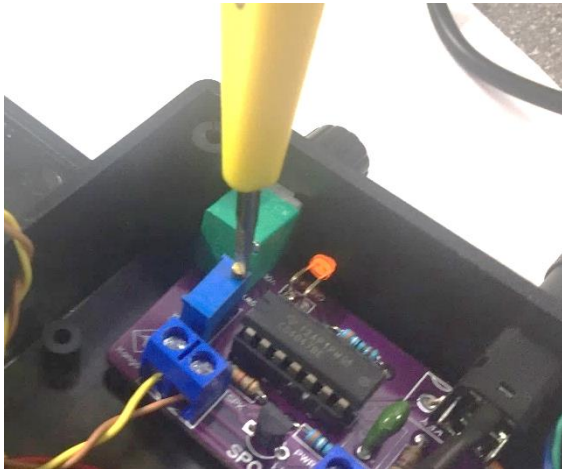

The PCB has a small blue trimmer, this controls the pitch the easiest way to adjust this is to put a book on the key to hold it down so both hands are free and slowly turn the trimmer, this trimmer is a 10-turn type so the pitch should adjust smoothly as you adjust it. The tone you use is up to you. The starting tone will depend on the default setting of the trimmer, most seem to produce a very low pitch to start with. The tone quality will improve when the case is screwed together so just set the pitch you like (most use a pitch around 500-700Hz).

Once you're happy with the pitch put the base plate onto the box and screw it down, the foam strip should be over the battery pack (if fitted that way). The speaker is slightly off set so it will fit better one way round.

Fit the 4 supplied rubber feet on the base so that the unit doesn't move around on the desk top.

Now flip the unit over and if not already done for you attach the top sticker.



Well done you should now have a great little code practice oscillator that will give you years of good service.

I hope you have enjoyed building this.

As you progress with Morse you may decide to move on from a straight key and start with an iambic key. If so then consider building one of our uCPO advanced oscillators. That will work with either a straight key or an iambic paddle. The uCPO is much more advanced than this basic oscillator and even has a multimode Morse tutor built in. For more details see our web site and look for the uCPO Practice Oscillator.

Any problems, email me.

Thanks Paul MOB MN [sales@kanga-products.co.uk](mailto:sales@kanga-products.co.uk)